

تصميمات بسيطة متوافقة مع أي مخطط داخلي

Simple designs compatible with any interior plan.

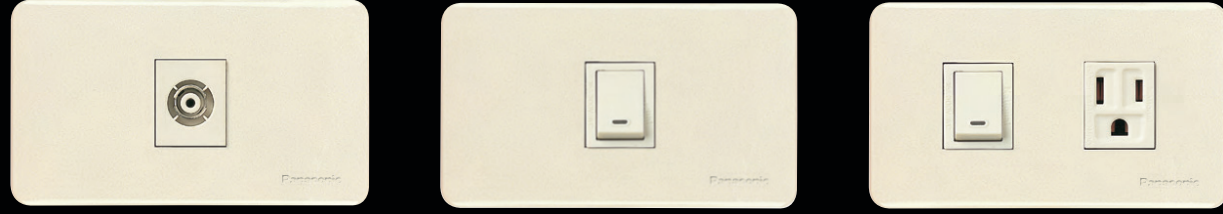

**FULL-COLOR**  
Series

**A-TYPE**

مجموعة واسعة من الألوان للاختيار من بينها لتنسيق الألوان المثالي

**WIDE RANGE OF  
COLORS TO SELECT  
FROM FOR PERFECT  
COLOR COORDINATION**



Designed for compatibility with any international wiring standards and installation requirements.

أحدث آلية تبديل مقاومة للحرارة وسهلة الاستخدام

**HEAT-RESISTANT,  
EASY-TO-USE LATEST  
SWITCH MECHANISM**



A basic Panasonic wiring device with simple, trouble-free switch mechanism.

تضمن ميزات الموثوقية العالية السلامة

**HIGH RELIABILITY  
FEATURES ENSURE  
SAFETY**



- European RoHS Directives compliant, totally free of Cd, Hg, Cr6+, Pb, PBB and PBDE substances
- Fire-retardant materials used to prevent core components burning
- CE mark displayed

FULL-COLOR WIDE SERIES  
Refine A-TYPE

FULL-COLOR WIDE SERIES  
A-TYPE

FULL-COLOR SERIES  
A-TYPE

FULL-COLOR SERIES A-TYPE

★ Screw Terminal  
Please check applicable wires  
in technical details.

اكسسورات  
Switches

**WNG5001-791**  
1Way Switch, 15AX 250V  
**WNG500107-SA** Coming Soon  
1Way Switch, 16AX 250V  
<Beige> **WNG6801W-P** (Plate)  
<Gold> **WNF7741Y** (Plate)  
<Chrome> **WNF7741S** (Plate)  
1-Gang 1-Device



★

Combination Model number  
**WNGP5110630** □□

**WNG5002-791**  
2Way Switch, 15AX 250V  
**WNG500207-SA** Coming Soon  
2Way Switch, 16AX 250V  
<Beige> **WNG6801W-P** (Plate)  
<Gold> **WNF7741Y** (Plate)  
<Chrome> **WNF7741S** (Plate)  
1-Gang 1-Device



★

Combination Model number  
**WNGP5210630** □□

**WNG5151-751**  
1Way Illuminated Switch,  
16AX 250V  
<Beige> **WNG6801W-P** (Plate)  
<Gold> **WNF7741Y** (Plate)  
<Chrome> **WNF7741S** (Plate)  
1-Gang 1-Device



★

Combination Model number  
**WNGP5119630** □□

\*Stock only for KSA & Kuwait

**WNG5152-751**  
2Way Illuminated Switch,  
16AX 250V  
<Beige> **WNG6801W-P** (Plate)  
<Gold> **WNF7741Y** (Plate)  
<Chrome> **WNF7741S** (Plate)  
1-Gang 1-Device



★

Combination Model number  
**WNGP5219630** □□

\*Stock only for KSA & Kuwait

**WNG5021-7-P**  
1Way Twin Switch, 10AX 250V  
<Beige> **WNG6801W-P** (Plate)  
<Gold> **WNF7741Y** (Plate)  
<Chrome> **WNF7741S** (Plate)  
1-Gang 1-Device



★

Combination Model number  
**WNGP5101610** □□

\*Stock Only

**WNG5001-791 X 4**  
1Way Switch, 15AX 250V  
**WNG500107-SA X 4** Coming Soon  
1Way Switch, 16AX 250V  
<Beige> **WNG6804W-P** (Plate)  
2-Gang 4-Device



★

Combination Model number  
**WNGP5140630**

\*Stock only for KSA & Kuwait

**WNG5151-751 X 4**  
1Way Illuminated Switch,  
16AX 250V  
<Beige> **WNG6804W-P** (Plate)  
2-Gang 4-Device



★

Combination Model number  
**WNGP5149630**

\*Stock only for KSA & Kuwait

**WNG5021-7-P X 4**  
1Way Twin Switch, 10AX 250V  
<Beige> **WNG6804W-P** (Plate)  
2-Gang 4-Device



★

Combination Model number  
**WNGP5181610**

\*Stock Only

**WNG5001-791 X 2**  
1Way Switch, 15AX 250V  
**WNG500107-SA X 2** Coming Soon  
1Way Switch, 16AX 250V  
<Beige> **WNG6802W-P** (Plate)  
<Gold> **WNF7742Y** (Plate)  
<Chrome> **WNF7742S** (Plate)  
1-Gang 2-Device



★

Combination Model number  
**WNGP5120630** □□

**WNG5002-791 X 2**  
2Way Switch, 15AX 250V  
**WNG500107-SA X 2** Coming Soon  
2Way Switch, 16AX 250V  
<Beige> **WNG6802W-P** (Plate)  
<Gold> **WNF7742Y** (Plate)  
<Chrome> **WNF7742S** (Plate)  
1-Gang 2-Device



★

Combination Model number  
**WNGP5220630** □□

**WNG5151-751 X 2**  
1Way Illuminated Switch,  
16AX 250V  
<Beige> **WNG6802W-P** (Plate)  
<Gold> **WNF7742Y** (Plate)  
<Chrome> **WNF7742S** (Plate)  
1-Gang 2-Device



★

Combination Model number  
**WNGP5129630** □□

\*Stock only for KSA & Kuwait

**WNG5152-751 X 2**  
2Way Illuminated Switch,  
16AX 250V  
<Beige> **WNG6802W-P** (Plate)  
<Gold> **WNF7742Y** (Plate)  
<Chrome> **WNF7742S** (Plate)  
1-Gang 2-Device



★

Combination Model number  
**WNGP5229630** □□

\*Stock only for KSA & Kuwait

**WNG5021-7-P X 2**  
1Way Twin Switch, 10AX 250V  
<Beige> **WNG6802W-P** (Plate)  
<Gold> **WNF7742Y** (Plate)  
<Chrome> **WNF7742S** (Plate)  
1-Gang 2-Device



★

Combination Model number  
**WNGP5141610** □□

\*Stock Only

**WNG5001-791 X 6**  
1Way Switch, 15AX 250V  
**WNG500107-SA X 6** Coming Soon  
1Way Switch, 16AX 250V  
<Beige> **WNG6806W-P** (Plate)  
2-Gang 6-Device



★

Combination Model number  
**WNGP5160630**

\*Stock only for KSA & Kuwait

**WNG5151-751 X 6**  
1Way Illuminated Switch,  
16AX 250V  
<Beige> **WNG6806W-P** (Plate)  
2-Gang 6-Device



★

Combination Model number  
**WNGP5169630**

\*Stock only for KSA & Kuwait

**WNG5021-7-P X 6**  
1Way Twin Switch, 10AX 250V  
<Beige> **WNG6806W-P** (Plate)  
2-Gang 6-Device



★

Combination Model number  
**WNGP5162610**

\*Stock Only

**WNG5001-791 X 3**  
1Way Switch, 15AX 250V  
**WNG500107-SA X 3** Coming Soon  
1Way Switch, 16AX 250V  
<Beige> **WNG6803W-P** (Plate)  
<Gold> **WNF7743Y** (Plate)  
<Chrome> **WNF7743S** (Plate)  
1-Gang 3-Device



★

Combination Model number  
**WNGP5130630** □□

**WNG5002-791 X 3**  
2Way Switch, 15AX 250V  
**WNG500107-SA X 3** Coming Soon  
2Way Switch, 16AX 250V  
<Beige> **WNG6803W-P** (Plate)  
<Gold> **WNF7743Y** (Plate)  
<Chrome> **WNF7743S** (Plate)  
1-Gang 3-Device



★

Combination Model number  
**WNGP5230630** □□

**WNG5151-751 X 3**  
1Way Illuminated Switch,  
16AX 250V  
<Beige> **WNG6803W-P** (Plate)  
<Gold> **WNF7743Y** (Plate)  
<Chrome> **WNF7743S** (Plate)  
1-Gang 3-Device



★

Combination Model number  
**WNGP5139630** □□

\*Stock only for KSA & Kuwait

**WNG5152-751 X 3**  
2Way Illuminated Switch,  
16AX 250V  
<Beige> **WNG6803W-P** (Plate)  
<Gold> **WNF7743Y** (Plate)  
<Chrome> **WNF7743S** (Plate)  
1-Gang 3-Device



★

Combination Model number  
**WNGP5239630** □□

\*Stock only for KSA & Kuwait

**WNG5021-7-P X 3**  
1Way Twin Switch, 10AX 250V  
<Beige> **WNG6803W-P** (Plate)  
<Gold> **WNF7743Y** (Plate)  
<Chrome> **WNF7743S** (Plate)  
1-Gang 3-Device



★

Combination Model number  
**WNGP5161610** □□

\*Stock Only

**WNG5002-791 X 4**  
2Way Switch, 15AX 250V  
**WNG500207-SA X 4** Coming Soon  
2Way Switch, 16AX 250V  
<Beige> **WNG6804W-P** (Plate)  
2-Gang 4-Device



★

Combination Model number  
**WNGP5240630**

\*Stock only for KSA & Kuwait

**WNG5152-751 X 4**  
2Way Illuminated Switch,  
16AX 250V  
<Beige> **WNG6804W-P** (Plate)  
2-Gang 4-Device



★

Combination Model number  
**WNGP5249630**

\*Stock only for KSA & Kuwait

**WNG5002-791 X 6**  
2Way Switch, 15AX 250V  
**WNG500207-SA X 6** Coming Soon  
2Way Switch, 16AX 250V  
<Beige> **WNG6806W-P** (Plate)  
2-Gang 6-Device



★

Combination Model number  
**WNGP5260630**

**WNG5152-751 X 6**  
2Way Illuminated Switch,  
16AX 250V  
<Beige> **WNG6806W-P** (Plate)  
2-Gang 6-Device



★

Combination Model number  
**WNGP5269630**

\*Stock only for KSA & Kuwait

الوان متنوعة  
Variety of Colors  
\*For combination  
model number



Beige

★Gold and Chrome type require mounting strap.

FULL-COLOR WIDE SERIES  
Refine A-TYPE

FULL-COLOR WIDE SERIES  
A-TYPE

FULL-COLOR SERIES  
A-TYPE

FULL-COLOR WIDE SERIES  
Refine A-TYPE

FULL-COLOR WIDE SERIES  
A-TYPE

FULL-COLOR SERIES  
A-TYPE

FULL-COLOR SERIES A-TYPE

★ Screw Terminal  
Please check applicable wires in technical details.

**WNG5004-7**  
Intermediate Switch, 4Way, 10AX 250V  
<Beige> **WNG6801W-P** (Plate)  
<Gold> **WNF7741Y** (Plate)  
<Chrome> **WNF7741S** (Plate)  
1-Gang 1-Device



★  
Combination Model number  
**WNGP5513630** □□

\*Stock Only

**WNG5401-7K**  
Push Button, 10AX 300V  
<Beige> **WNG6801W-P** (Plate)  
<Gold> **WNF7741Y** (Plate)  
<Chrome> **WNF7741S** (Plate)  
1-Gang 1-Device



★  
Combination Model number  
**WNGP5113650** □□

**WNG5461-7**  
Push Button, 10A 300V (Appellation)  
<Beige> **WNG6801W-P** (Plate)  
<Gold> **WNF7741Y** (Plate)  
<Chrome> **WNF7741S** (Plate)  
1-Gang 1-Device



Combination Model number  
**WNGP5113660** □□

**WNG5461-7 X 2**  
Push Button, 10A 300V (Appellation)  
<Beige> **WNG6802W-P** (Plate)  
<Gold> **WNF7742Y** (Plate)  
<Chrome> **WNF7742S** (Plate)  
1-Gang 2-Device

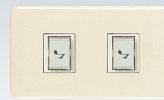

Combination Model number  
**WNGP5123660** □□

**WNGP5438693K**  
45A DP Switch with Indicator and Plate, Pillar Terminal



★  
**WNGP5438693** □□ (old model)  
**WBG5408699**  
45A DP Switch with Indicator  
**WN3020** Blank Chip  
<Beige> **WNG6803W-P** (Plate)  
<Gold> **WNF7743Y** (Plate)  
<Chrome> **WNF7743S** (Plate)  
1-Gang 3-Device

مقابس  
Socket Outlets

**WNGP13217** NEW  
13A 250V 1-Gang Unswitched Socket Outlet with Plate



★

الوان متنوعة  
Variety of Colors  
\*For combination model number

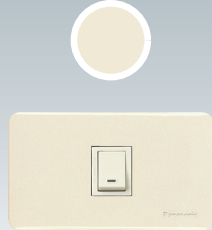

Beige  
□□

\*Gold and Chrome type require mounting strap.

Accessories اكسسوارات

**WNTG15649**  
Telephone Socket 6P4C  
<Beige> **WNG6801W-P** (Plate)  
<Gold> **WNF7741Y** (Plate)  
<Chrome> **WNF7741S** (Plate)  
1-Gang 1-Device



Combination Model number  
**WNGP4519940** □□

**WNTG15649 X 2**  
Telephone Socket 6P4C  
<Beige> **WNG6802W-P** (Plate)  
<Gold> **WNF7742Y** (Plate)  
<Chrome> **WNF7742S** (Plate)  
1-Gang 2-Device



Combination Model number  
**WNGP4529940** □□

**WZ1201-P**  
TV Socket DIN Type  
<Beige> **WNG6801W-P** (Plate)  
<Gold> **WNF7741Y** (Plate)  
<Chrome> **WNF7741S** (Plate)  
1-Gang 1-Device



Combination Model number  
**WNGP4719830** □□

**WZ1201-P X 2**  
TV Socket DIN Type  
<Beige> **WNG6802W-P** (Plate)  
<Gold> **WNF7742Y** (Plate)  
<Chrome> **WNF7742S** (Plate)  
1-Gang 2-Device



Combination Model number  
**WNGP4729830** □□

**WNG2741** NEW  
TV Socket F Type  
<Beige> **WNG6801W-P** (Plate)  
<Gold> **WNF7741Y** (Plate)  
<Chrome> **WNF7741S** (Plate)  
1-Gang 1-Device



Combination Model number  
**WNGP4719450** □□

**WNG2741 X 2** NEW  
TV Socket F Type  
<Beige> **WNG6802W-P** (Plate)  
<Gold> **WNF7742Y** (Plate)  
<Chrome> **WNF7742S** (Plate)  
1-Gang 2-Device



Combination Model number  
**WNGP4729450** □□

**WNTG15649** NEW  
Telephone Socket 6P4C  
**WNG2741**  
TV Socket F Type  
<Beige> **WNG6802W-P** (Plate)  
<Gold> **WNF7742Y** (Plate)  
<Chrome> **WNF7742S** (Plate)  
1-Gang 2-Device



Combination Model number  
**WNGP45299471** □□

**WZ1201-P**  
TV Socket DIN Type  
**WNTG15649**  
Telephone Socket 6P4C  
<Beige> **WNG6802W-P** (Plate)  
<Gold> **WNF7742Y** (Plate)  
<Chrome> **WNF7742S** (Plate)  
1-Gang 2-Device



Combination Model number  
**WNGP4529942** □□

**NR3160-8**  
Cat 5E Outlet  
<Beige> **WNG6801W-P** (Plate)  
<Gold> **WNF7741Y** (Plate)  
<Chrome> **WNF7741S** (Plate)  
1-Gang 1-Device



Combination Model number  
**WNGP4519980** □□

**NR3170-8**  
Cat 6 Outlet  
<Beige> **WNG6801W-P** (Plate)  
<Gold> **WNF7741Y** (Plate)  
<Chrome> **WNF7741S** (Plate)  
1-Gang 1-Device



Combination Model number  
**WNGP4519680** □□

**WNTG15649**  
Telephone Socket 6P4C  
**NR3170-8**  
Cat 6 Outlet  
<Beige> **WNG6802W-P** (Plate)  
<Gold> **WNF7742Y** (Plate)  
<Chrome> **WNF7742S** (Plate)  
1-Gang 2-Device



Combination Model number  
**WNGP4529649** □□

**NR3170-8**  
Cat 6 Outlet  
**WNG2741**  
TV Socket F Type  
<Beige> **WNG6802W-P** (Plate)  
<Gold> **WNF7742Y** (Plate)  
<Chrome> **WNF7742S** (Plate)  
1-Gang 2-Device



Combination Model number  
**WNGP4529949** □□

## FULL-COLOR SERIES A-TYPE

### شاحن USB USB Charger

**WNF10718**  
1-port USB Charger  
<Beige> **WNG6803W-P** (Plate)  
<Gold> **WNF7743Y** (Plate)  
<Chrome> **WNF7743S** (Plate)  
1-Gang 3-Device



Combination Model number  
**WNGP1426123**

**WNF10728**  
2-port USB Charger  
<Beige> **WNG6803W-P** (Plate)  
<Gold> **WNF7743Y** (Plate)  
<Chrome> **WNF7743S** (Plate)  
1-Gang 3-Device



Combination Model number  
**WNGP1072**

FULL-COLOR WIDE SERIES  
Refine A-TYPE

FULL-COLOR WIDE SERIES  
A-TYPE

FULL-COLOR SERIES  
A-TYPE

### الوان متنوعة Variety of Colors

\*For combination model number

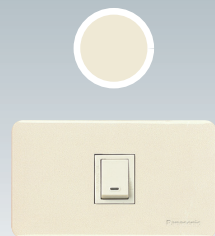

**Beige**



\*Gold and Chrome type require mounting strap.

FULL-COLOR WIDE SERIES  
Refine A-TYPE

FULL-COLOR WIDE SERIES  
A-TYPE

FULL-COLOR SERIES  
A-TYPE

FULL-COLOR SERIES BS-TYPE , A-TYPE

مفاتيح كهربائية 45 أمبير  
Switches 15AX

BS-TYPE 1Way Switch



WNG5001-791  
WNB7801

WNBP5110630



WNG5001-791  
WNB7802

WNBP5120630



WNG5001-791  
WNB7803

WNBP5130630

A-TYPE 1Way Switch

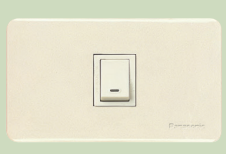

WNG5001-791  
WNG6801W-P

WNGP5110630

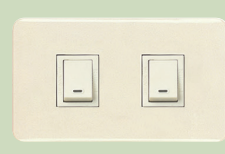

WNG5001-791  
WNG6802W-P

WNGP5120630

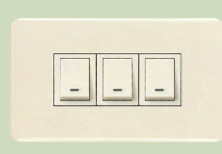

WNG5001-791  
WNG6803W-P

WNGP5130630

FULL-COLOR Series

FULL-COLOR SERIES BS-TYPE , A-TYPE

مفاتيح كهربائية 45 أمبير  
Switches 45A

BS-TYPE DP Switch with Indicator



OLD MODEL  
WBG5408699  
WNB7802

WNBP5428690

NEW MODEL  
WNBP5428690K



OLD MODEL  
WBG5408699  
WNB7817

WNBP5448690

NEW MODEL  
WNBP5448690K

A-TYPE DP Switch with Indicator

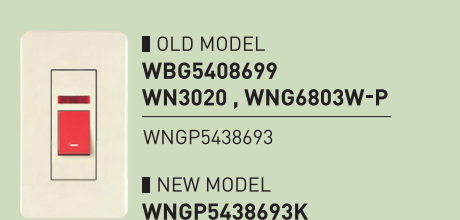

OLD MODEL  
WBG5408699  
WN3020 , WNG6803W-P

WNGP5438693

NEW MODEL  
WNGP5438693K

FULL-COLOR Series

Technical Specifications الموصفات الفنية

- |  |   |
|--|---|
| <ul style="list-style-type: none"> <li>▶ Standards<br/>Comply with IEC60669-1</li> <li>▶ Rating<br/>15AX 250V~</li> <li>▶ Ambient Temperature<br/>-10°C – +40°C</li> <li>▶ Representative Performance                     <ul style="list-style-type: none"> <li>• Electric strength : 2,000V 1 min</li> <li>• Operation test : 40,000 Operations</li> <li>• Temperature rise : Test current 20A (2.5 mm<sup>2</sup>)<br/>Not more than 45K (Terminals)</li> </ul> </li> </ul> | <ul style="list-style-type: none"> <li>▶ Terminal<br/>Screw Terminal</li> <li>▶ Applicable Wire<br/>1.5 mm<sup>2</sup> - 3.5 mm<sup>2</sup><br/>14 AWG - 12 AWG</li> <li>▶ Terminal Capacity<br/>1.5 mm<sup>2</sup> × 1<br/>3.5 mm<sup>2</sup> × 1<br/>14 AWG × 1<br/>12 AWG × 1</li> </ul> |
|--|---|
- \*Supply terminal has 2 terminal holes.

Features المميزات

- Clean designs and extensive product range.
- Compact tumbler switch delivers a distinct click feel.
- Made with flame-retardant and heat-resistant urea resins.
- Switching mechanism uses a coil spring system for a longer service life.
- Metal plate makes the switch ideally suited for a wide range of uses, including offices and restaurants.

Dimensions الأبعاد

BS-TYPE 1Way Switch

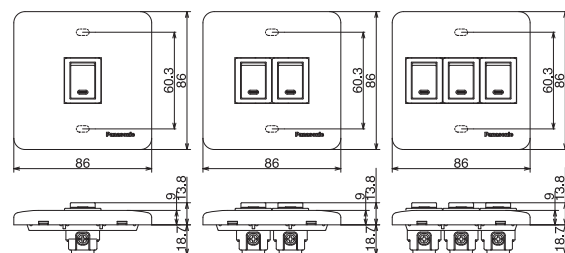

A-TYPE 1Way Switch

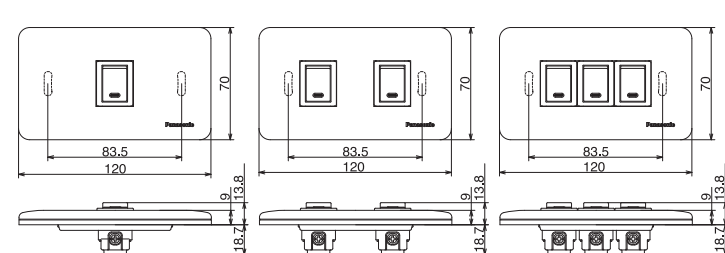

Technical Specifications الموصفات الفنية

- |  |  |
|--|--|
| <ul style="list-style-type: none"> <li>▶ Standards<br/>Comply BS EN 60669-1</li> <li>▶ Rating<br/>45A 250V~ (Resistive)<br/>Motor Full load current of 25A or less,<br/>power factor of 0.8 or more</li> <li>▶ Ambient Temperature<br/>-10°C – +40°C</li> <li>▶ Representative Performance                     <ul style="list-style-type: none"> <li>• Electric strength : 1,500V 1 min</li> <li>• Operation test : 10,000 operations</li> <li>• Temperature rise : Test current 51A (16 mm<sup>2</sup>)<br/>Not more than 45K (Terminals)</li> </ul> </li> </ul> | <ul style="list-style-type: none"> <li>▶ Terminal<br/>Pillar Terminal</li> <li>▶ Applicable Wire<br/>[Solid] 4 mm<sup>2</sup><br/>[Stranded] 4 mm<sup>2</sup> - 16 mm<sup>2</sup><br/>[AWG] AWG 10 - AWG 6</li> <li>▶ Terminal Capacity<br/>4 mm<sup>2</sup> × 2<br/>6 mm<sup>2</sup> × 2<br/>10 mm<sup>2</sup> × 1<br/>16 mm<sup>2</sup> × 1</li> </ul> |
|--|--|

Features المميزات

- High-capacity silver contact for longer life.
- Made with flame-retardant and heat-resistant melamine phenol/urea resins.
- Conductive section uses heat-resistant copper with superior anticorrosion property and conductivity for long-term stable, reliable performance.
- Built-in lighted indicator shows On/Off status.
- Normal gap double-pole switch (minimum contact gap : 3 mm) construction ensures safe load shut-off.
- Double Earth Terminal.

Dimensions الأبعاد

BS-TYPE DP Switch with Indicator

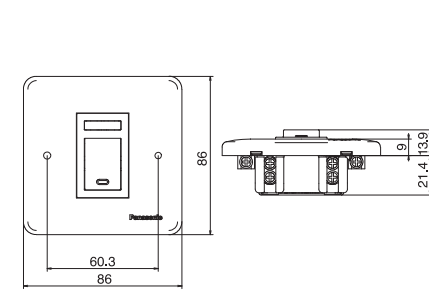

A-TYPE DP Switch with Indicator

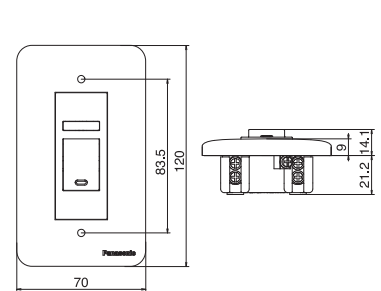

\*BS-TYPE : M3.5 mounting screws included.

FULL-COLOR SERIES BS-TYPE , A-TYPE

ديمر لتحديد شدة الاضاءة  
Dimmer Switches

BS-TYPE 500W (Low Voltage)

LED Dimmer



WEG578153-FC  
WNB7872  
WNB5781530



WEG57912-FC  
WNB7872  
WNB579120



WEG57815-FC  
WNB7872  
WBP579150

FULL-COLOR Series

FULL-COLOR SERIES BS-TYPE

مقابس  
Socket Outlets

BS-TYPE Switched Socket



WNB1111K



WNB11119

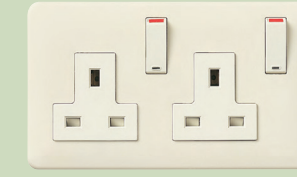

WNB1112K

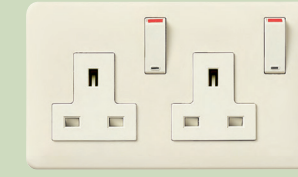

WNB11129

FULL-COLOR Series

Technical Specifications الموصفات الفنية

WEG578153-FC

- ▶ Rating : 220V-240V~ 500W
- ▶ Ambient Temperature : 0°C – +35°C
- ▶ Terminal : Screw Terminal
- ▶ Applicable Wire : 1 mm<sup>2</sup>- 2.5 mm<sup>2</sup>

WNB579120 / WNB579150

- ▶ Rating:220V-240V- 50/60Hz
- ▶ LED 50W(WNB579120)
- ▶ LED200W(WNB579150)
- ▶ Ambient Temperature:0°C - 35°C
- ▶ Terminal : Pillar (WNB579120)  
Screw(WNB579150)
- ▶ Applicable Wire: 1mm<sup>2</sup>- 2.5mm<sup>2</sup>(WNB579120)  
1mm<sup>2</sup>- 4mm<sup>2</sup>(WNB579150)

Features المميزات

WEG578153-FC

- Applicable Wires : 1 mm<sup>2</sup> - 2.5 mm<sup>2</sup>
- Compatible with 500VA copper/ steel and step-down transformers.
- Applicable for low-voltage halogen lamp use.
- Applicable for 500W incandescent lamp.

WNB579120 / WNB579150

Applicable incandescent lamps & low voltage halogen lamps & LED bulbs

- Chandelier lamp Silica lamp Clear lamp Hi-beam lamp
- Halogen lamp LED dimmable bulb

- When using low voltage halogen lamps, requires an applicable transformer to convert voltage from 220 V - 240 V to 12 V.
- The brightness when dimmed is different depending on the LED bulb types and Brand.
- When the knob is lower limit, brightness is different depending on the LED bulb types and Brand.
- Be sure to use a light bulb with a built-in fuse.  
Not doing so may result in damage to the dimmer switch when the light bulb burns out.

\*Those products can't operate ventilating / ceiling fan.

Dimensions الأبعاد

BS-TYPE 500W (Low Voltage)

LED Dimmer

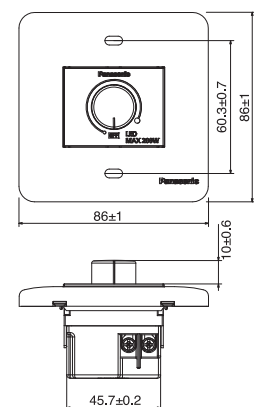
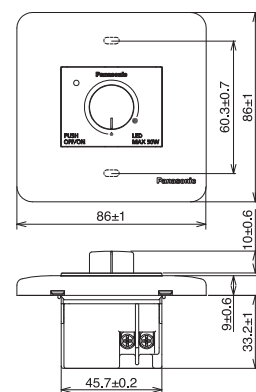
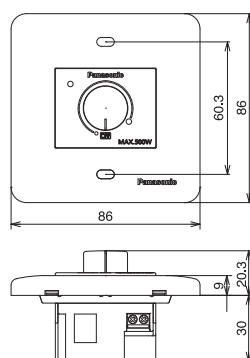

\*BS-TYPE : M3.5 mounting screws included.

Technical Specifications الموصفات الفنية

- ▶ Standards  
Comply with BS1363-2 and IEC60884-1
- ▶ Rating  
13A 250V~
- ▶ Ambient Temperature  
-10°C – +40°C
- ▶ Representative Performance  
·Electric strength : 2,000V 1 min  
·Operation test : 15,000 times (30,000 movements)  
·Temperature rise : Test current 20A (2.5 mm<sup>2</sup>)  
Not more than 52K (Terminals)

- ▶ Terminal  
Pillar Terminal II
- ▶ Applicable Wire  
1.5 mm<sup>2</sup> - 4 mm<sup>2</sup>  
15 AWG - 12 AWG
- ▶ Terminal Capacity  
1.5 mm<sup>2</sup> × 3  
2.5 mm<sup>2</sup> × 3  
4 mm<sup>2</sup> × 2

Features المميزات

- Receptacle with a double-pole switch completely isolates load from power supply.
- Receptacle housing uses flame-retardant and heat-resistant urea resin with high anti-tracking properties.
- Accepts wires : 1.5 mm<sup>2</sup> - 4 mm<sup>2</sup> solid wire to flexible wire.
- Both socket and switch components have adequate switching capability.
- Included safety shutter prevents kids from tampering with switch.

Dimensions الأبعاد

BS-TYPE Switched Socket

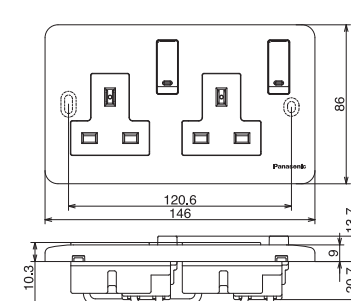
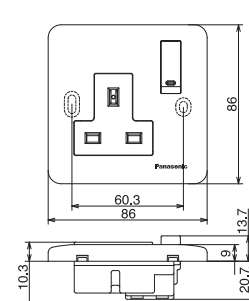

BS-TYPE : M3.5 mounting screws included.

Applicable Box العلبه المناسبة

BS-TYPE

- ▶ Dimensions  
Plate : 86 x 86 mm  
Box : 72 x 72 mm  
Fixing Center : 60.3 mm

- ▶ Dimensions  
Plate : 86 x 146 mm  
Box : 72 x 132 mm  
Fixing Center : 120.6 mm

FULL-COLOR SERIES BS-TYPE , A-TYPE

FULL-COLOR Series

اكسسورات TV  
Accessories - Television

BS-TYPE DIN Type

F Type

A-TYPE DIN Type

F Type



WZ1201-P  
WNB7801

WNB4719830



WNG3063  
WNB7801

WNB4719450



WNG2741  
WEB7801

WNB4716450

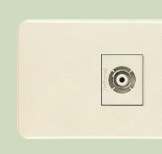

WZ1201-P  
WNG6801W-P

WNG4719830



WNG2741  
WNG6801W-P

WNG4719450

FULL-COLOR SERIES BS-TYPE , A-TYPE

FULL-COLOR Series

اكسسورات هاتف  
Accessories - Telephone

BS-TYPE 6P4C

A-TYPE 6P4C



WNTG15649  
WNB7801

WNB4519940



WNTG15649  
WNB7802

WNB4529940

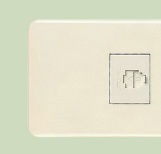

WNTG15649  
WNG6801W-P

WNG4519940

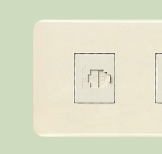

WNTG15649  
WNG6802W-P

WNG4529940

Technical Specifications الموصفات الفنية

- ▶ Connector Type (Outlet) : DIN Type
- ▶ Terminal  
Screw Terminal Type (Only coaxial core isn't screw terminal type)
- ▶ Impedance Input, Outlet : 75Ω
- ▶ Applicable Cable  
Coaxial Cable Characteristic Impedance 75Ω type : 5C - 2V, 3C - 2V

Features المميزات

“Easy Connect” terminal for direct insertion of coaxial cable core.

Insert fully and tighten clamp.

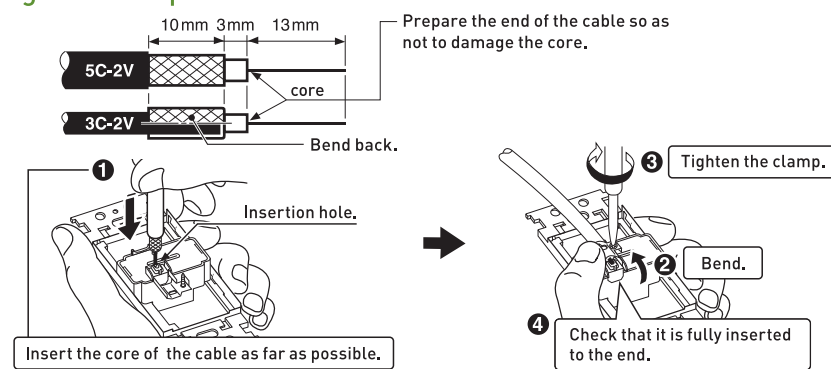

Dimensions الأبعاد

BS-TYPE DIN Type

A-TYPE DIN Type

F Type

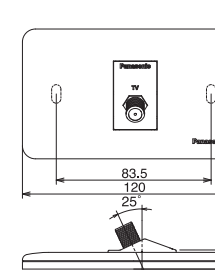
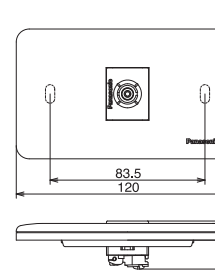
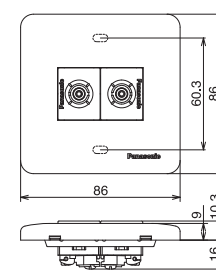
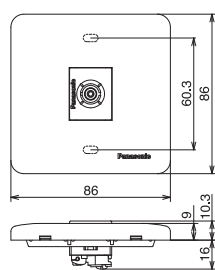

\*BS-TYPE : M3.5 mounting screws included.

Technical Specifications الموصفات الفنية

- ▶ Connector Type  
Miniature Modular Jack, 6 position with 4-contacts, specified in TIA-1096-A (Previously in FCC part 68)
- ▶ Terminal  
Quick Connect Terminal (Screwless Terminal)
- ▶ Applicable Wire  
Paired quad-type PVC indoor cable : Core wire to be 0.4 mm, 0.5 mm, 0.65 mm, in diameter (solid copper only)  
2-pair Business-phone indoor cable : Core wire to be 0.4 mm, 0.5 mm, 0.65 mm, in diameter (solid copper only)

Features المميزات

- Quick Connect Terminal increases connection reliability.
- Quick Connect Terminal for easy connection.
- Simple Connection  
Just insert cable into the terminal hole.
- Easy Cable Disconnection  
Push removal button while pulling out cable.

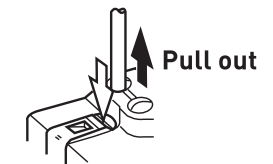
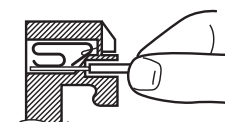

Dimensions الأبعاد

BS-TYPE 6P4C

A-TYPE 6P4C

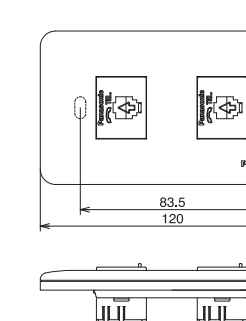
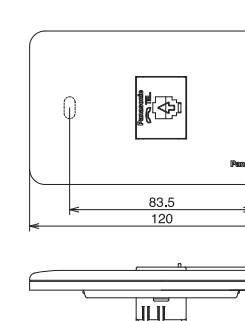
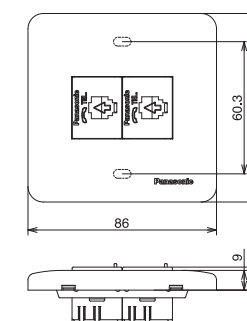
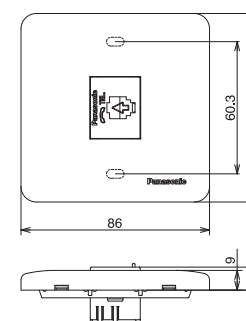

\*BS-TYPE : M3.5 mounting screws included.

FULL-COLOR SERIES BS-TYPE , A-TYPE

FULL-COLOR Series

اكسسورات انترنت  
Accessories - LAN

BS-TYPE Category 5e , Category 6

A-TYPE Category 5e

Category 6



NR3160-8  
WNB7801

WBNP4519980

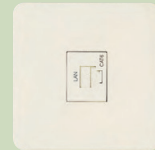

NR3170-8  
WNB7801

WBNP4519680



NR3160-8  
WNG6801W-P

WNGP4519980



NR3170-8  
WNG6801W-P

WNGP4519680

Technical Specifications الموصفات الفنية

- ▶ Connector Type  
"8-way unshielded fixed connector (miniature 8-position modular jack)" specified in IEC 60603-7
- ▶ Terminal  
IDC connection
- ▶ Applicable Cable  
NR3160-8 : 4-pair UTP cable, Category 5e  
Conductor : solid copper wire, 22 AWG - 24 AWG (diameter : 0.5 mm - 0.65 mm)  
: or stranded copper wire, 24 AWG  
NR3170-8 : 4-pair UTP cable, Category 6  
Conductor : solid copper wire, 22 AWG - 24 AWG (diameter : 0.5 mm - 0.65 mm)

Features المميزات

1 It's not necessary to use special wiring tool.

2 No need to untwist the wires.

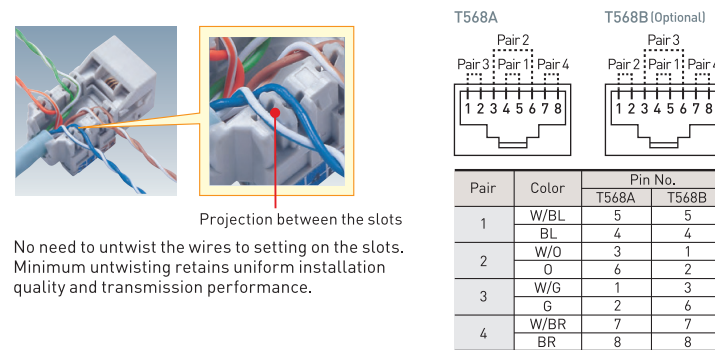
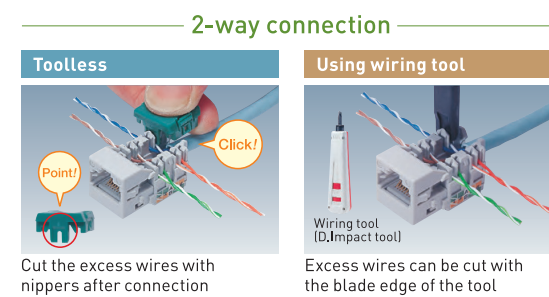

Dimensions الأبعاد

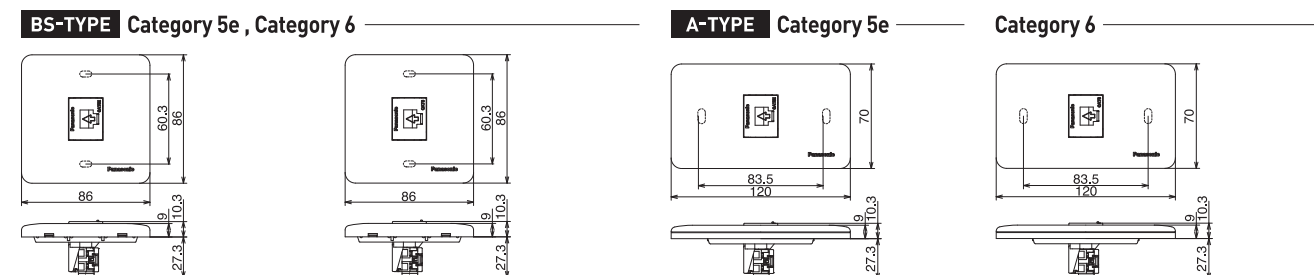

\*BS-TYPE : M3.5 mounting screws included.

FULL-COLOR SERIES BS-TYPE , A-TYPE

FULL-COLOR Series

اخرى  
Others

4G Switch



WBNP545227

Technical Specifications الموصفات الفنية

- ▶ Standards  
Comply with BS3676 : 1989
- ▶ Rating  
10AX 250V~
- ▶ Ambient Temperature  
-10°C - +40°C
- ▶ Representative Performance  
·Electric strength : 2,000V 1 min  
·Operation test : 40,000 Operations  
·Temperature rise : Test current 20A (2.5 mm<sup>2</sup>)  
Not more than 45K (Terminals)
- ▶ Terminal  
Screw Terminal
- ▶ Applicable Wire  
1.0 mm<sup>2</sup> - 2.5 mm<sup>2</sup>
- ▶ Terminal Capacity  
1.5 mm<sup>2</sup> × 1  
3.5 mm<sup>2</sup> × 1  
14 AWG × 1  
12 AWG × 1

Intermediate Switch



WBNP5513630

Technical Specifications الموصفات الفنية

- ▶ Standards  
Comply with IEC60669-1
- ▶ Rating  
10AX 250V~
- ▶ Ambient Temperature  
-10°C - +40°C
- ▶ Representative Performance  
·Electric strength : 2,000V 1 min  
·Operation test : 40,000 Operations  
·Temperature rise : Test current 13.5A (2.5 mm<sup>2</sup>)  
Not more than 45K (Terminals)
- ▶ Terminal  
Screw Terminal
- ▶ Applicable Wire  
1.5 mm<sup>2</sup> - 3.5 mm<sup>2</sup>  
14 AWG - 12 AWG
- ▶ Terminal Capacity  
1.5 mm<sup>2</sup> × 1  
3.5 mm<sup>2</sup> × 1  
14 AWG × 1  
12 AWG × 1

Push Button



WBNP5113650



WBNP5113660

Technical Specifications الموصفات الفنية

- ▶ Standards  
Comply with IEC60669-1
- ▶ Rating  
10A 300V
- ▶ Ambient Temperature  
-10°C - +40°C
- ▶ Representative Performance  
·Electric strength : 2,000V 1 min  
·Operation test : 40,000 Operations  
·Temperature rise : Test current 13.5A (2.5 mm<sup>2</sup>)  
Not more than 45K (Terminals)
- ▶ Terminal  
Screw Terminal
- ▶ Applicable Wire  
0.75 mm<sup>2</sup> - 2 mm<sup>2</sup>
- ▶ Terminal Capacity  
0.75 mm<sup>2</sup> × 1  
1 mm<sup>2</sup> × 1  
1.5 mm<sup>2</sup> × 1  
2 mm<sup>2</sup> × 1  
16 AWG × 1  
14 AWG × 1



3G Wire Grounding Socket

Technical Specifications الموصفات الفنية



WBNP1619600 WBNP1629600

- ▶ Standards  
Comply with IEC60884-1
- ▶ Rating  
15A 127V~
- ▶ Ambient Temperature  
-10°C – +40°C
- ▶ Representative Performance  
·Electric strength : 2,000V 1 min  
·Operation test : 5,000 times (10,000 movements)  
·Temperature rise : Test current 15A (2.5 mm<sup>2</sup>)  
Not more than 45K (Terminals)
- ▶ Terminal  
Screw Terminal
- ▶ Applicable Wire  
1.5 mm<sup>2</sup> - 3.5 mm<sup>2</sup>  
14 AWG - 12 AWG
- ▶ Terminal Capacity  
1.5 mm<sup>2</sup> × 1  
3.5 mm<sup>2</sup> × 1  
14 AWG × 1  
12 AWG × 1

Universal Socket

Technical Specifications الموصفات الفنية



WBNP1914610

- ▶ Standards  
Comply with IEC60884-1
- ▶ Rating  
16A 250V~
- ▶ Ambient Temperature  
-10°C – +40°C
- ▶ Representative Performance  
·Electric strength : 2,000V 1 min  
·Operation test : 5,000 times (10,000 movements)  
·Temperature rise : Test current 22A (2.5 mm<sup>2</sup>)  
Not more than 45K (Terminals)
- ▶ Terminal  
Screw Terminal
- ▶ Applicable Wire  
1.5 mm<sup>2</sup> - 3.5 mm<sup>2</sup>  
14 AWG - 12 AWG
- ▶ Terminal Capacity  
1.5 mm<sup>2</sup> × 1  
2.5 mm<sup>2</sup> × 1  
14 AWG × 1  
12 AWG × 1

BS13A + USB

Technical Specifications الموصفات الفنية



WNB11114

- ▶ Standards: Comply with  
BS1363, BS5733, IEC62368-1, EN62368-1
- ▶ Rating: Socket Outlet:13A 250V~  
USB:2.1A 5V
- ▶ Ambient Temperature: -5°C - +40°C]
- ▶ Representative Performance:  
- Electric strength : 1,500V 1 min  
- Operation test :  
Socket Outlet: 15,000 times  
(30,000 movements)  
- Temperature rise :  
Test current 20A (2.5 mm<sup>2</sup>)  
Not more than 47K (Terminals)
- ▶ Terminal: Pillar Terminal
- ▶ Applicable Wire:  
2.5 mm<sup>2</sup> – 6.0 mm<sup>2</sup> /  
14 AWG – 12 AWG
- ▶ Terminal Capacity:  
2.5 mm<sup>2</sup> x 3, 4 mm<sup>2</sup> x 2, 6 mm<sup>2</sup> x 1

15A 3Pin Socket

Technical Specifications الموصفات الفنية



WNB1131K

- ▶ Standards  
Comply with BS546
- ▶ Rating  
15A 250V~
- ▶ Ambient Temperature  
-10°C – +40°C
- ▶ Representative Performance  
·Electric strength : 1,500V 1 min  
·Operation test : 15,000 times (30,000 movements)  
·Temperature rise : Test current 15A (2.5 mm<sup>2</sup>)  
Not more than 35K (Terminals)
- ▶ Terminal  
Screw Terminal
- ▶ Applicable Wire  
2.5 mm<sup>2</sup> - 4 mm<sup>2</sup> (L,N terminal)  
1.5 mm<sup>2</sup> - 4 mm<sup>2</sup> (E terminal)
- ▶ Terminal Capacity  
1.5 mm<sup>2</sup> × 3  
2.5 mm<sup>2</sup> × 3  
4 mm<sup>2</sup> × 2

BS13A + USB

Technical Specifications الموصفات الفنية

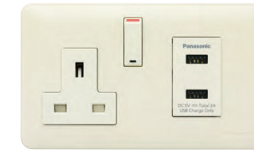

WNB111159

- ▶ Standards  
Comply with  
Socket: BS 1362-2 and IEC 60884-2-3  
USB: IEC 60950-1
- ▶ Rating  
Socket Outlet : 13A 250V~  
USB Charger : DC 5V 2.0A
- ▶ Ambient Temperature  
-10°C – +40°C
- ▶ Representative Performance  
·Electric strength : 2,000V 1 min  
·Operation test  
Socket Outlet : 15,000 times  
(30,000 movements)  
USB Charger : 10,000 times  
·Temperature rise : Test current 20A (2.5mm<sup>2</sup>)  
Not more than 52K (Terminals)
- ▶ Terminal  
Pillar Terminal II
- ▶ Applicable Wire  
2.5 mm<sup>2</sup> - 4 mm<sup>2</sup> Stranded  
Diameter 1.78 mm - 2.25 mm

EL Guard

Technical Specifications الموصفات الفنية



WNB17419

- ▶ Standards  
Comply with  
Socket: BS 1362-2 and IEC 60884-2-3  
RCD: IEC 62640
- ▶ Rating  
Socket Outlet: 13A 220-240V  
Rated Frequency: 50-60Hz  
Rated Residual Operating Current 30mA  
Rated Residual Making and Breaking Capacity 250A  
Rated conditional short-circuit current 1500A  
Rated Conditional residual short-circuit current 1500A
- ▶ Breaktime  
300 ms or less (at rated residual operating current)  
150ms or less (at 2X rated residual operating current)  
40ms or less (at 5X rated residual operating current)  
Rated Residual Non-Operating Current 15mA  
Leakage Waveform: Type AC
- ▶ Opening /Closing:4,000 Times  
(Opening 2,000/Closing 2,000)
- ▶ Ambient Temperature:  
-5°C – +40°C
- ▶ Representative Performance:  
·Electric strength : 2,000V 1 min  
·Operation test  
Socket Outlet : 15,000 times  
(30,000 movements)  
·Temperature rise : Test current 20A (2.5mm<sup>2</sup>)  
Not more than 52K (Terminals)
- ▶ Terminal  
Pillar Terminal II
- ▶ Applicable Wire  
1.5 mm<sup>2</sup> - 4 mm<sup>2</sup> Stranded  
Diameter 1.38 mm - 2.25 mm

Cooker Control Unit

Technical Specifications الموصفات الفنية



WNB111169

- ▶ Standards  
Comply with  
Socket: BS 1362-2 and IEC 60884-2-3  
Switch: IEC 60669-1
- ▶ Rating  
Switch : 45A 250V~  
Socket Outlet : 13A 250V~
- ▶ Ambient Temperature  
-10°C – +40°C
- ▶ Representative Performance  
·Electric strength : 1,500V 1 min  
·Operation test  
Switch : 20,000 Operations  
Socket Outlet : 15,000 times  
(30,000 movements)
- Temperature rise : Test current 51A (16 mm<sup>2</sup>)  
Not more than 45K (Terminals)
- ▶ Terminal  
Pillar Terminal
- ▶ Applicable Wire  
4 mm<sup>2</sup> - 16 mm<sup>2</sup> Stranded  
[AWG] AWG 10 – AWG 6

### HDMI connector



WBNP42150

#### Technical Specifications الموصفات الفنية

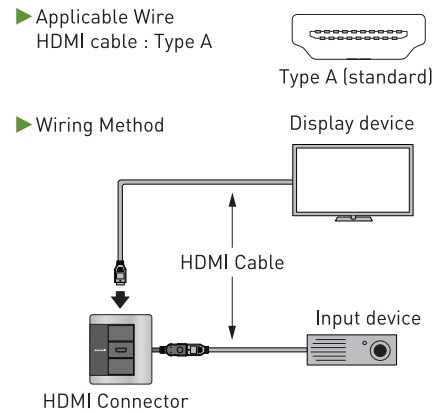

### 13A socket without Switch



WBNP13117

#### Technical Specifications الموصفات الفنية

- ▶ Standards  
Comply with BS1363-2 and IEC60884-1
- ▶ Rating  
13A 250V~
- ▶ Ambient Temperature  
-10°C – +40°C
- ▶ Representative Performance  
·Electric strength : 2,000V 1 min  
·Operation test : 15,000 times (30,000 movements)  
·Temperature rise : Test current 20A (2.5 mm<sup>2</sup>)  
Not more than 52K (Terminals)
- ▶ Terminal  
Pillar Terminal II
- ▶ Applicable Wire  
1.5 mm<sup>2</sup> - 4 mm<sup>2</sup>  
15 AWG - 12 AWG
- ▶ Terminal Capacity  
1.5 mm<sup>2</sup> × 3  
2.5 mm<sup>2</sup> × 3  
4 mm<sup>2</sup> × 2

### 45A, 20A Cable outlet



WNB7010

WNB7020

#### Technical Specifications الموصفات الفنية

- ▶ Standards and Approvals  
Comply with BS5733
- ▶ Ambient Temperature  
-5°C – +40°C
- ▶ Representative Performance  
·Electric strength : 2,000V 1min  
·Temperature rise :  
WNB7010 : Test current 22A (4 mm<sup>2</sup>)  
WNB7020 : Test current 49.5A (6 mm<sup>2</sup>)  
Not more than 47K (Terminals)
- ▶ Terminal  
Pillar Terminal
- ▶ Applicable Wire  
WNB7010  
Input/Output : 2.5 mm<sup>2</sup> - 6 mm<sup>2</sup>  
(Rigid Copper Wire)  
1.5 mm<sup>2</sup> - 2.5 mm<sup>2</sup>  
(Flexible Electrical Wire)  
WNB7020:  
Input/Output : 6 mm<sup>2</sup> - 10 mm<sup>2</sup>  
(Rigid Copper Wire)  
4 mm<sup>2</sup> - 6 mm<sup>2</sup>  
(Flexible Electrical Wire)
- ▶ Terminal Capacity  
WNB7010  
Input 2.5 mm<sup>2</sup>, 4 mm<sup>2</sup>  
6 mm<sup>2</sup>, × 1  
Output 1.5 mm<sup>2</sup>,  
2.5 mm<sup>2</sup>, × 1  
WNB7020  
: Input 6 mm<sup>2</sup>, 10 mm<sup>2</sup>  
Output 4 mm<sup>2</sup>, 6 mm<sup>2</sup>

### HARMONY BS-TYPE

Harmony

## مفاتيح كهربائية 10 امبير Switches 10AX

#### BS-TYPE 1Way Switch



WBC5011



WBC5021



WBC5031



WBC5061

#### 2Way Switch

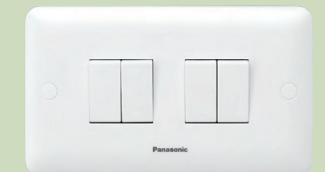

WBC5042

#### Technical Specifications الموصفات الفنية

- ▶ Standards  
Comply with BSEN60669-1
- ▶ Rating  
10AX 250V~
- ▶ Ambient Temperature  
-5°C – +40°C
- ▶ Representative Performance  
·Electric strength : 2,000V 1 min  
·Operation test : 40,000 Operations  
·Temperature rise : Test current 13.5A (2.5 mm<sup>2</sup>)  
Not more than 45K (Terminals)
- ▶ Terminal  
Pillar Terminal
- ▶ Applicable Wire  
1 mm<sup>2</sup> - 4 mm<sup>2</sup>
- ▶ Terminal Capacity  
1.5 mm<sup>2</sup> × 3  
2.5 mm<sup>2</sup> × 2  
4 mm<sup>2</sup> × 1

#### Features المميزات

- Compact tumbler switch delivers a distinct click feel.
- Made with flame-retardant and heat-resistant urea resins.
- Construction integrated with plate maintains overall compact dimensions.
- Accepts wires : 1 mm<sup>2</sup> - 4 mm<sup>2</sup> solid wire and stranded wire.

#### Dimensions الأبعاد

#### BS-TYPE 1Way Switch

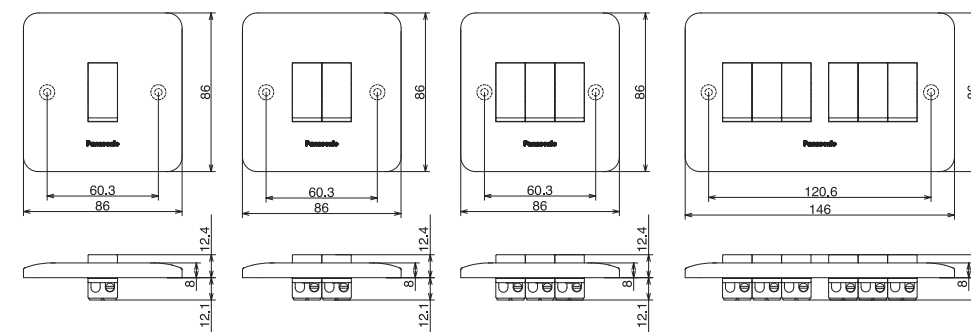

#### 2Way Switch

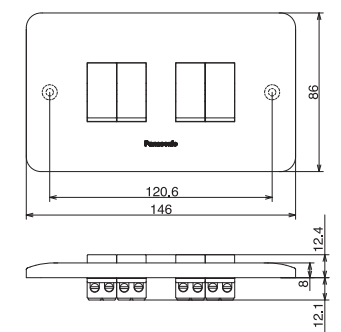

\*BS-TYPE : M3,5 mounting screws included.